



HAJAR AL-EHRAMAT

COMMITTED IN
SURPASSING THE
EXPECTATIONS OF OUR
CLIENTS.



Iraq , Mathna Province ,Al- Samwa , Al-Hey
gharbi , Basatin Mohamad Ali raof , Ali Radid
Bld.



E-mail: info@hajarindustrial.com



: +971581361695- +9647838371105



About Us

HAJAR AL-EHRAMAT possesses the most important 4Ms- Machine, Men, Money and Material for ensuring mainline cross country Engineering and Construction solutions for installation of gas and oil projects.

Our workforce mainly includes HSSE, time bound and cost effective budgetary solutions to execution of projects to achievement of the targets as per the specified schedule. we have been offering services to numerous clients and meeting their specific requirements successfully, in short time we have been successful in attaining a credible position in Iraq.

We have drawn the best available talents from the industry to build an efficient team for providing Pipeline Work Services and Earth Moving Machines . Our team consists of experienced technocrats, engineers, skilled workers, supervisors and business development managers. Each of these members is committed to provide quality work to the clients and earn company's preset goals on. Our team works in perfect coordination and completes the projects on time. It is our team's hard work, knowledge and determination that put us on the path of success.



OUR TEAM



A LEADER IN THE FIELD
OF
**ELECTROMECHANICAL
ENGINEERING**
CONTRACTING,
INSTALLATION,
TESTING &
COMMISSIONING
AND MAINTENANCE.

Technical Department

ENGINEERING INSTALLATION,
TESTING & COMMISSIONING

Piping Department : Piping fabrication and installation

Email: hajar.al.ehramat.co@gmail.com

Structure department :Steel structure fabrication and installation

Email: info@hajarindustrial.com

Mechanical department : Mechanical installation , static and rotational

Email: hha@hajarindustrial.com

ECI Department : Electrical , instrumentation and control installation

Email: ali.m@hajarindustrial.com



A Glimpse into Our Electrical Department

- Detail Engineering :
- Cable routing
- ECI Cable list
- Instrument list
- PLC and HMI programing
- Hookup drawing
- SLD and detail engineering of power system
- power system design and study ,cable sizing , relay co ordination
- Signal list
- I/O list
- MCC waring diagram

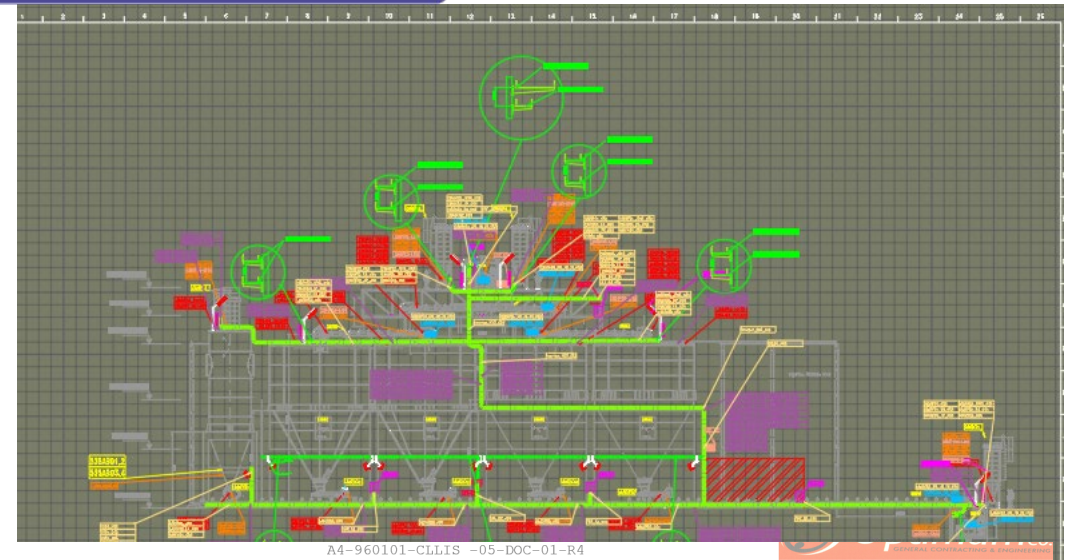

4/15

A4-960101-CLLIS -05-DOC-01-R4

NO	Signal description	Type	From	To	cable Tag	Cable Size	Cable length	services voltage	
32	295BC04Belt conveyor Misalignment switch in Tail right	Local signal	field	295BC04_DR_JB01	295BC04_D03A0_LS_C01	(3X1.5)+SCR	10	220 VAC	
33	295BC04Belt conveyor Misalignment switch in Tail left	Local signal	field	295BC04_DR_JB01	295BC04_D04A0_LS_C01	(3X1.5)+SCR	10	220 VAC	
34	295BC04Belt conveyor Pull rope switch in Left Side	Local signal	field	295BC04_DR_JB01	295BC04_R01A0_LS_C01	(3X1.5)+SCR	10	220 VAC	
35	295BC04Belt conveyor Pull rope switch in Right Side	Local signal	field	295BC04_DR_JB01	295BC04_R02A0_LS_C01	(3X1.5)+SCR	10	220 VAC	
36	295BC05Belt conveyor Misalignment switch _MISS EMG Trip	DI	295BC05_DR_JB01	new -I/O panel	295BC05_DR_JB_DI_C01	(3X1.5)+SCR	95	220 VAC	
		Local signal	field	295BC05_DR_JB01	295BC05_D01A0_LS_C01	(3X1.5)+SCR	10	220 VAC	
		Local signal	field	295BC05_DR_JB02	295BC05_D02A0_LS_C01	(3X1.5)+SCR	10	220 VAC	
		Local signal	field	295BC05_DR_JB03	295BC05_D03A0_LS_C01	(3X1.5)+SCR	10	220 VAC	
		Local signal	field	295BC05_DR_JB04	295BC05_D04A0_LS_C01	(3X1.5)+SCR	10	220 VAC	
		Local signal	field	295BC05_DR_JB05	295BC05_R01A0_LS_C01	(3X1.5)+SCR	10	220 VAC	
		Local signal	field	295BC05_DR_JB01	295BC05_R02A0_LS_C01	(3X1.5)+SCR	10	220 VAC	
		rip	DI	535BC01_DR_JB01	new -I/O panel	535BC01_DR_JB_DI_C01	(3X1.5)+SCR	50	220 VAC
		Local signal	field	535BC01_DR_JB01	535BC01_D01A0_LS_C01	(3X1.5)+SCR	60	220 VAC	
		Local signal	field	535BC01_DR_JB01	535BC01_D02A0_LS_C01	(3X1.5)+SCR	60	220 VAC	
		Local signal	field	535BC01_DR_JB01	535BC01_D03A0_LS_C01	(3X1.5)+SCR	60	220 VAC	
		Local signal	field	535BC01_DR_JB01	535BC01_D04A0_LS_C01	(3X1.5)+SCR	60	220 VAC	
		Local signal	field	535BC01_DR_JB01	535BC01_R01A0_LS_C01	(3X1.5)+SCR	60	220 VAC	
		Local signal	field	535BC01_DR_JB01	535BC01_R02A0_LS_C01	(3X1.5)+SCR	60	220 VAC	
		rip	DI	535BC02_DR_JB01	new -I/O panel	535BC02_DR_JB_DI_C01	(3X1.5)+SCR	40	220 VAC
		Local signal	field	535BC02_DR_JB01	535BC02_D01A0_LS_C01	(3X1.5)+SCR	35	220 VAC	
		Local signal	field	535BC02_DR_JB01	535BC02_D02A0_LS_C01	(3X1.5)+SCR	35	220 VAC	
		Local signal	field	535BC02_DR_JB01	535BC02_D03A0_LS_C01	(3X1.5)+SCR	35	220 VAC	



A4-960101-INSLIS -05-DOC-01-R6

9/11

6. LEVEL SWITCH AND TRANSMITTER

NO	Description	Instrument Tag. No	Type	Signal type	Order number	Remarks	Rev
1	level of Gypsum silo 1_2953S01	2953S01_L01I01	Radar	Analogue	PS68XXAK2HKMXX	Vega Plus 68	3
2	level of Gypsum silo 2_2953S02	2953S02_L01I01	Radar	Analogue	PS68XXAK2HKMXX	Vega Plus 68	3
3	level of Lime stone silo 1_2953S03	2953S03_L01I01	Radar	Analogue	PS68XXAK2HKMXX	Vega Plus 68	3
4	level of Lime stone silo 2_2953S04	2953S04_L01I01	Radar	Analogue	PS68XXAK2HKMXX	Vega Plus 68	3
5	level of Alkaline Silo_4A53S01	4A53S01_L01I01	Radar	Analogue	PS68XXAK2HKMXX	Vega Plus 68	3
6	high level alarm of Gypsum silo 1_2953S01	2953S01_L01HA01	capacitive	Digital	CP65XXKGSRKMX	Vega Cap 65	3
7	high level alarm of Gypsum silo 2_2953S02	2953S02_L01HA01	capacitive	Digital	CP65XXKGSRKMX	Vega Cap 65	3
8	high level alarm of Lime stone silo 1_2953S03	2953S03_L01HA01	capacitive	Digital	CP65XXKGSRKMX	Vega Cap 65	3
9	high level alarm of Lime stone silo 2_2953S04	2953S04_L01HA01	capacitive	Digital	CP65XXKGSRKMX	Vega Cap 65	3
10	high level alarm of Alkaline Silo_4A53S01	4A53S01_L01HA01	capacitive	Digital	CP65XXKGSRKMX	Vega Cap 65	3

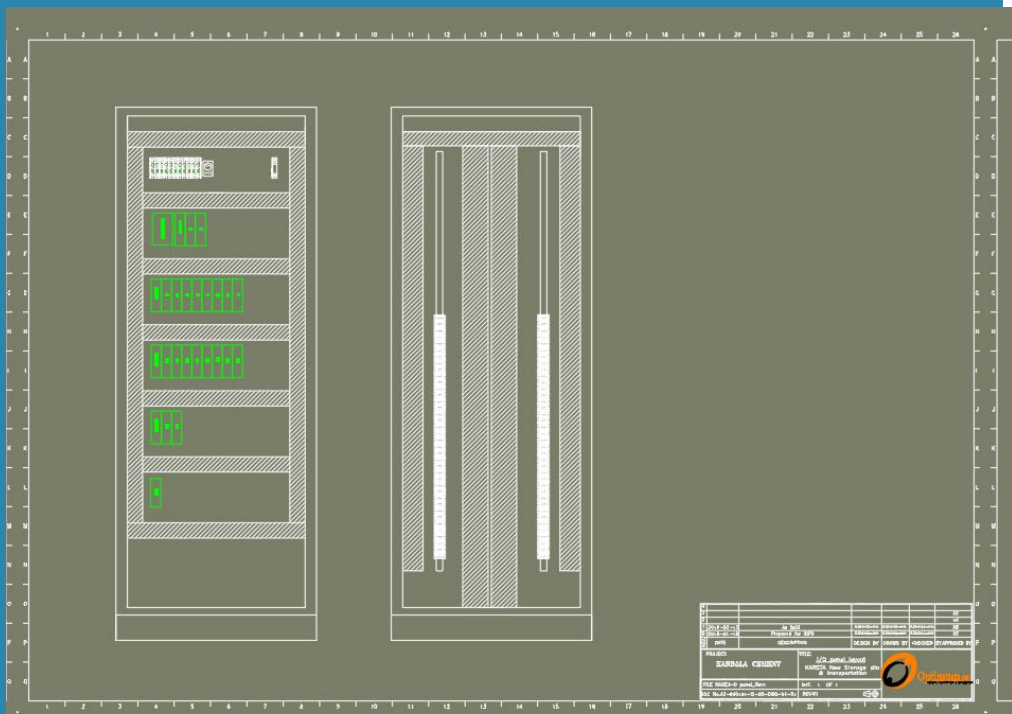

NO	REVISION	DATE	BY	CHKD
1				
2				

PROJECT	HAJARA AL-EHRAMAT
CLIENT	HAJARA AL-EHRAMAT
DESIGNER	PPK
CHECKER	PPK
APPROVED	PPK

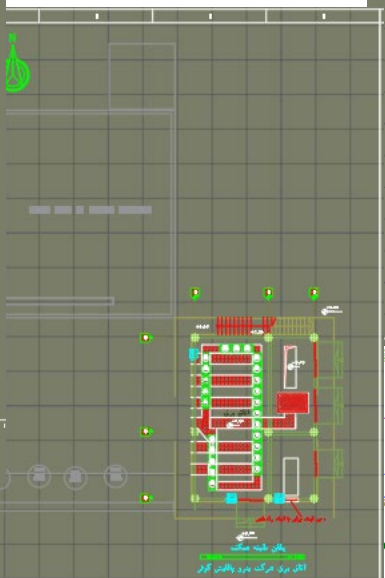

NO	REVISION	DATE	BY	CHKD
1				
2				

PROJECT	HAJARA AL-EHRAMAT
CLIENT	HAJARA AL-EHRAMAT
DESIGNER	PPK
CHECKER	PPK
APPROVED	PPK

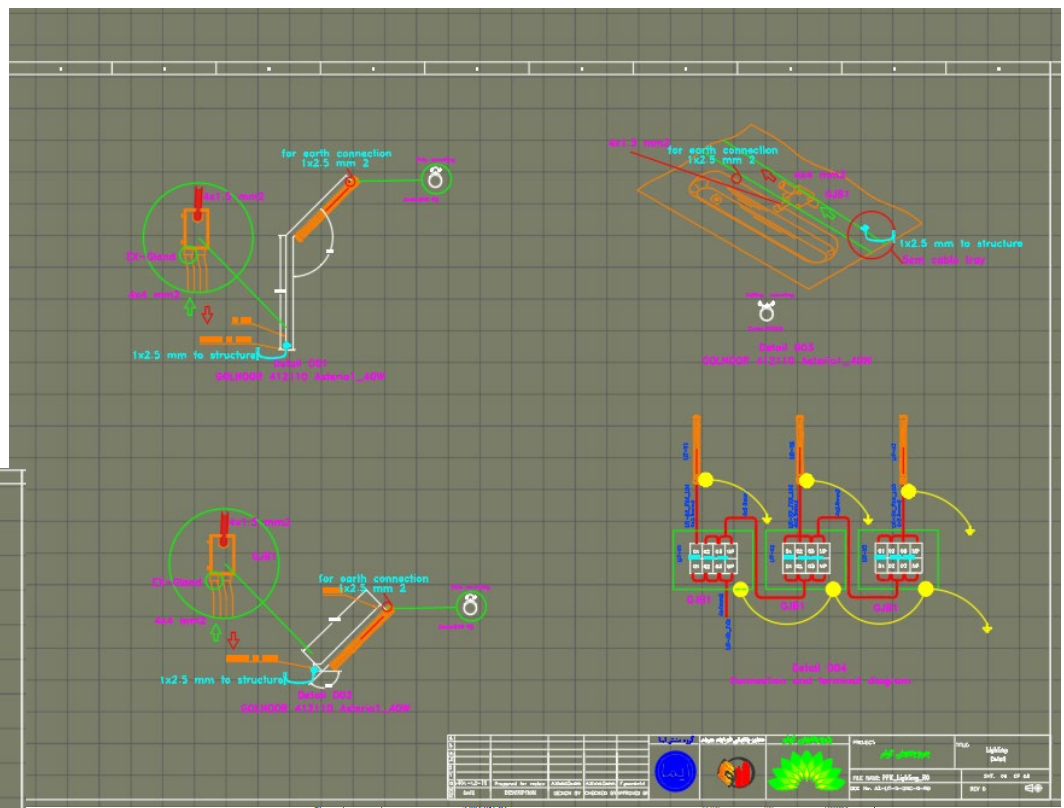

NO	REVISION	DATE	BY	CHKD
1				
2				

PROJECT	HAJARA AL-EHRAMAT
CLIENT	HAJARA AL-EHRAMAT
DESIGNER	PPK
CHECKER	PPK
APPROVED	PPK

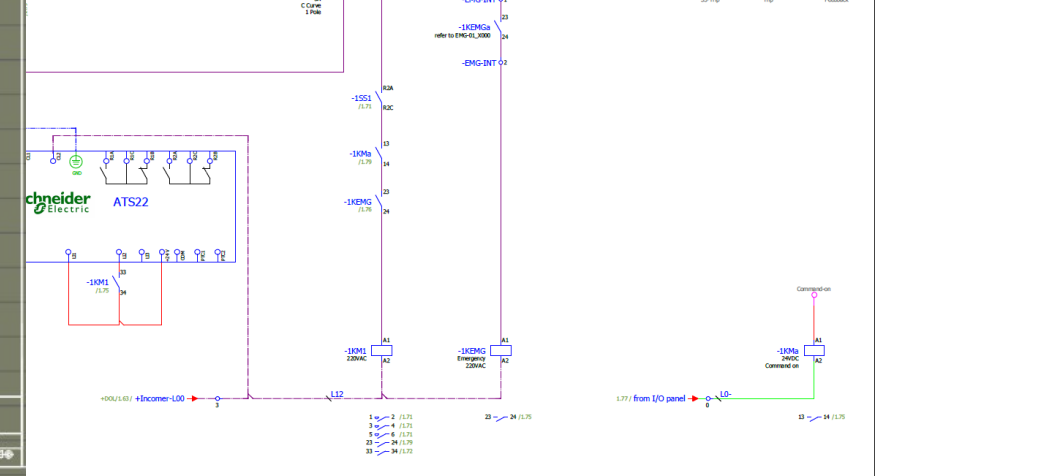



Procurement and supply

- E/C&I cables
- MV, LV panels
- PLC and local control panels
- Instruments
- Installation accessories





Installation and Commissioning :

- Cable tray installation
- Instrument installation and test
- Lighting and illumination
- Earthing and lightning protection
- Panel installation test and commissioning
- Cable laying and test
- Heat tracing
- Cathodic protection



Power system study and testing :

- Power system study /Relay coordination with Etap /testing and configuration of power protection relay:
- Soufian cement project, Iran
- Moghan water pump station, Aslandoz, Iran
- Kalhor Daneh Jonob (KDJ)Co., Mahshar, Iran
- Arvand Petrochemical Plant, Mahshar, Iran

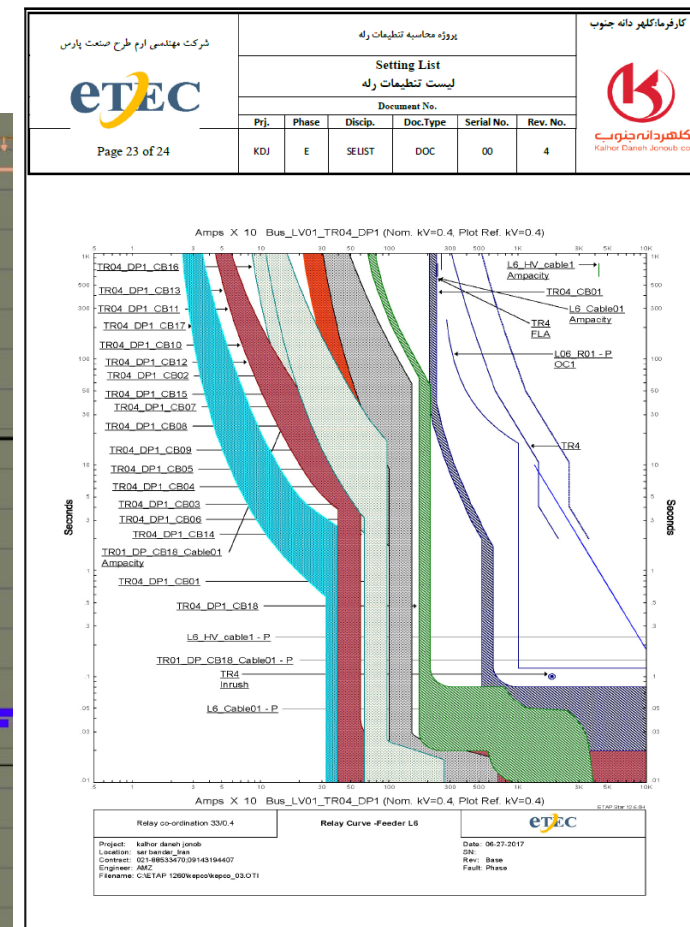
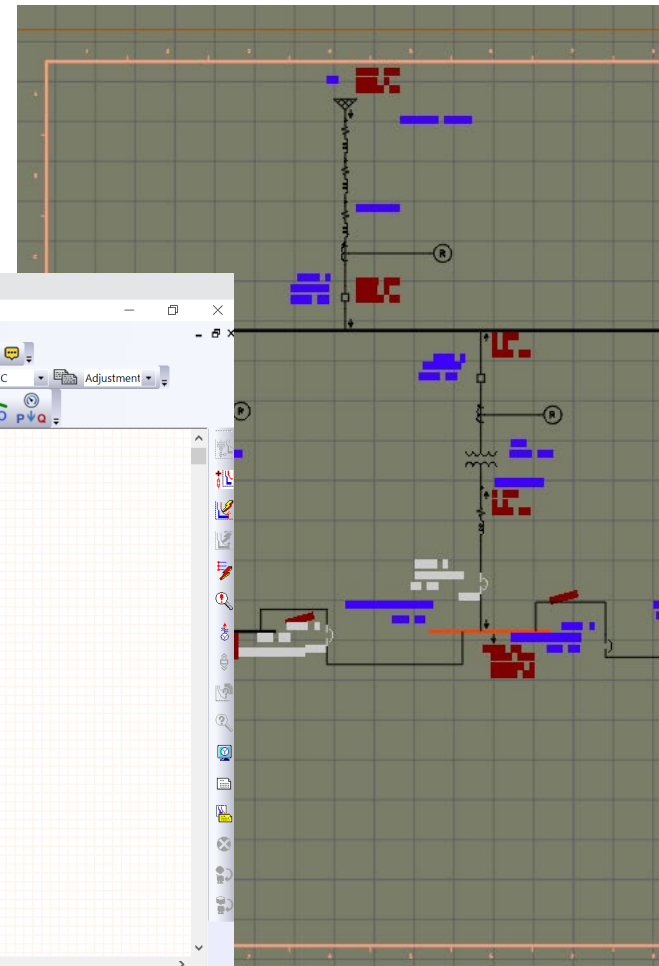
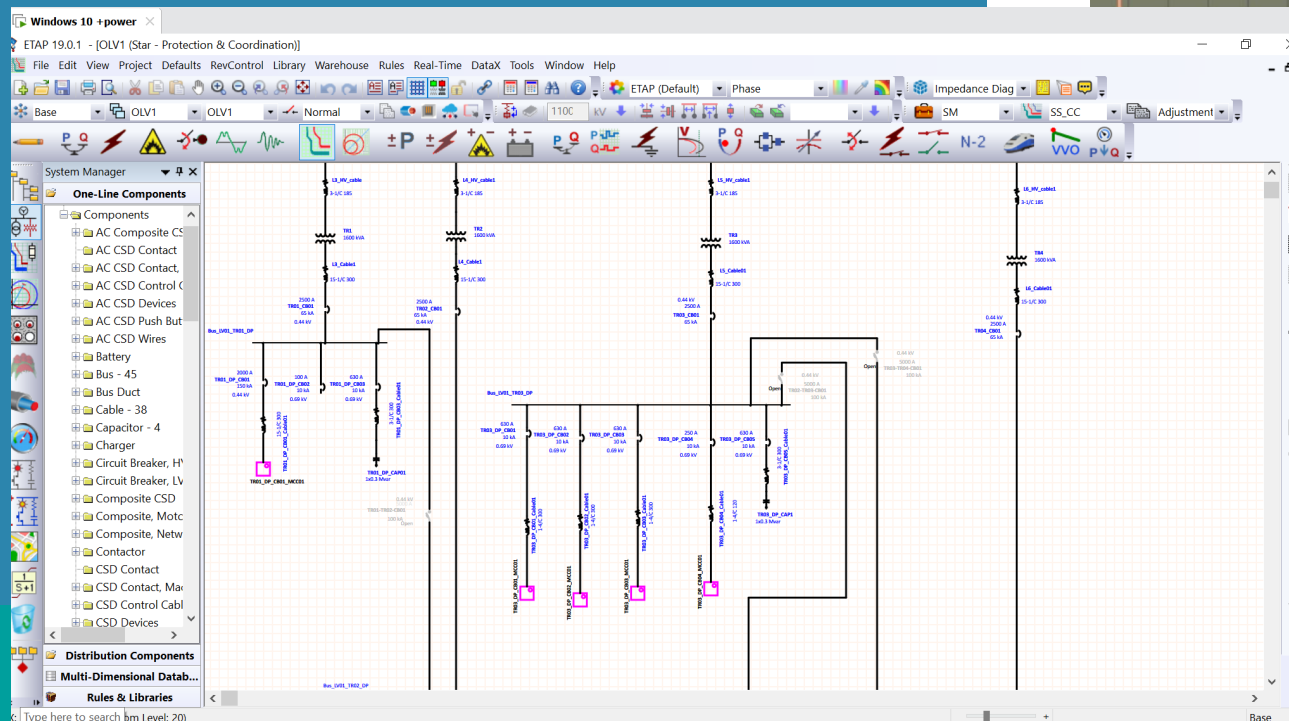



Date: 17.10.2022

No: 961

To whom it may concern

This is to certify that Mr. ALI MALEKZADEH, had been working for below projects in Iraq as project engineer of Electrical, Control and instrumentation for detail, basic engineering, supervision and commissioning.

With the reference of following and his performance during project execution, hereby we appreciate his outstanding quality of work.

Jun 2019~ January 2021: project engineer, responsible for basic and detail engineering and supervision and commissioning of Electrical, Control and instruments, pozzolana project cement production line, Tasluja, Iraq

August 2017~ August 2018: project engineer, responsible for basic and detail engineering and supervision and commissioning of Electrical, Control and instruments, SRC project cement production line, Tasluja, Iraq

April 2017~ may 2018 and February 2021~ March 2021: Project engineer, responsible for basic and detail engineering and supervision and commissioning of Electrical, Control and instruments, pozzolana cement production line, Karbala, Iraq (Holcim and Lafarge plant)

Humam Talib

Managing Director



(ALMETHALI) for general contracting and engineering LTD

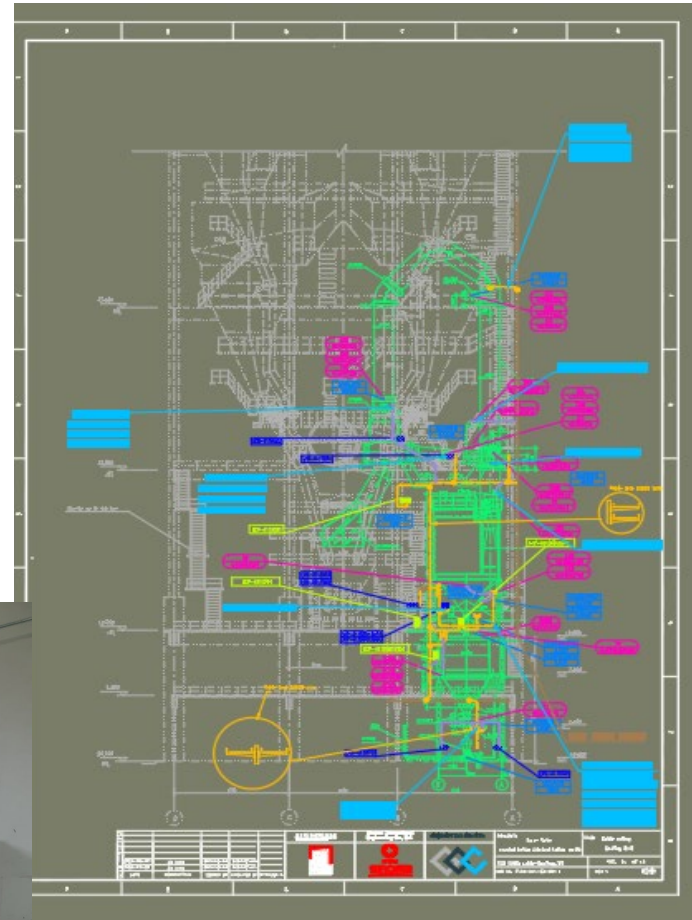



Engineering and supervision

- Soufian cement project expansion of kiln 3 and 4
- Songun Copper Plant phase II concentration

HOLTEC CONSULTING PRIVATE LIMITED
 Holtec Centre A Block, Sushant Lok,
 Gurgaon 122 001, Haryana, India
 Phone : +91-124-4047900, 2385095
 Fax : +91-124-2385114, 2385116

TO WHOM IT MAY CONCERN

This is to certify that Mr. Ali Malekzadeh was engaged/involved in design and engineering of electrical, control and instrumentation of Soufian cement project, from Soufian side during the execution of Soufian Cement Upgradation project of Kiln-3 & Kiln-4. Holtec was the Engineering Consultant for the upgradation project.

With the reference of above and considering his experience in this field, we are of the opinion that he is capable in engineering at electrical, C&I for cement plant.

For **HOLTEC Consulting Pvt.Ltd.**

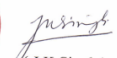
 (J K Singh)
 Chief General Manager : Consulting

Date : 11 January 2013

Email : info@holteconet.com

Web : www.holteconet.com

legd. Office : 01-0103, Imperial Tower, C Block Community Centre, Naraina Vihar, New Delhi-110 028 Phone : 25771002 Fax : 25771001



تاریخ : 1392/01/11
 شماره : 44-2385095
 شماره : 114-2385114
 شرکت خدمات مهندسی سیمان فارس و آذربایجان
 Fars and Azerbaijan Cement Engineering Services Co.

To whom it may concern

For the up gradation of Soufian Cement Company (SCC), Tabriz, Iran, I was overall responsible for project execution and Mr. Ali Malekzadeh has been working as head of the electrical engineering department for 80 month (21st April 2005 up to now) regarding him, I am delighted to express my feelings as below:

During the engineering stage Mr. Malekzadeh was responsible for the basic engineering, detailed engineering and procurement of electrical, instrument & control equipment, where he was instrumental in ordering the best available system at an affordable cost. He also followed up the suppliers globally to affect the delivery of equipment to suit the project schedule.

During the execution stage, he was responsible for the erection and commissioning of above equipment for which he helped the management in selection of the most competent Iranian organization, to carry out the job at a reasonable price. He developed the required formalts to monitor the project progress, to inform the contractor of the corrective actions and to provide feedback to the Management.

Mr. Malekzadeh is a capable and confident engineer. In addition he is a good manager too, having healthy relationship with the management, peers and the subordinates. He is conscious of the quality of engineering, equipment to be procured and erection/ commissioning of equipment as well as the project deadlines to be met. I am confident that he will be an asset to any organization, he works.

J Saeidi Bonatti
 Project Manager of Soufian cement
 Tabriz
 F&A - CES
 Cement Engineering Services Co.

Project list

- installation and commissioning of bypass system in , Gasin cement plant, Sulyamneh , Iraq (2022)
- detailed engineering and supervision of Electrical, petrol, and gasoline production plant at Petro Palayesh Kosar, Ajabshir, Iran (2021)
- basic and detail engineering, supervision, and commissioning of Butia steel ash conveying system in Kerman, Iran. (2021)
- detail engineering and supervision of the Electrical aspect of a 20,000-liter Ethanol production line at Middle East Sugar, Dezful, Iran. (2020)
- basic and detail engineering, supervision, and commissioning of Electrical, Control, and Instruments for the Pozzolana project cement production line at Almethali.co in Tasluja, Iraq. (2020)
- basic and detail engineering, supervision, and commissioning of Electrical, Control, and Instruments for SRC project cement production line at Almethali.co in Tasluja, Iraq.(2018)
- detail engineering, supervision, and commissioning of Electrical, Control, and Instruments for Pozzolana cement production line at Almethali.co in Karbala, Iraq (Holcim and Lafarge plant).(2018)
- Power system study and relay coordination and tested 33KV feeder for Kalhor Daneh Jonob (KDJ) Co. in Mahshar, Iran.(2017)
- commissioning of the PDCMS system in Arvand Petrochemical Plant, Mahshar, Iran.(2016)
- detail engineering and supervision of Electrical for CAN.Co. home appliances new production line in Tehran, Iran.(2016)
- detail engineering and supervision of Electrical, procurement contractor of Asphalt blowing unit at Behbod Sanat, Birjand, Iran.(2016)

- commissioning engineering for local panels (MCC and PLC) at bins silo, Sirjan, Iran. (2016)
- Commissioning of local panels (MCC and PLC) at pond area, Setareh Khalij Fars Refinery, Bandar Abbas, Iran.(2015)
- detail engineering and supervision of instrumentation for extending import/export jetty conveyors at Persian Gulf Mining and Metal Industries Special Zone, Bandar Abbas, Iran.(2014)
- pre-commissioning and commissioning of the water pump station, relay coordination, and test of 33KV feeder, Siemens-1000 liters/s, and other low voltage equipment at Moghan Water Pump Station, Aslandoz, Iran.(2012)
- commissioning of FLSA sub-PLC package, inlet and outlet gas analyzer, calciner oil and gas burner, lubricator of kiln ring at Soufian cement, Iran.(2010)
- coordination of Soufian cement Kiln 4 and configuring of 30 sets Siprotec - Siemens protection relay at Soufian cement project, Iran.(2010)



commissioning of the PDCMS system in Arvand Petrochemical Plant, Mahshar, Iran.(2016)

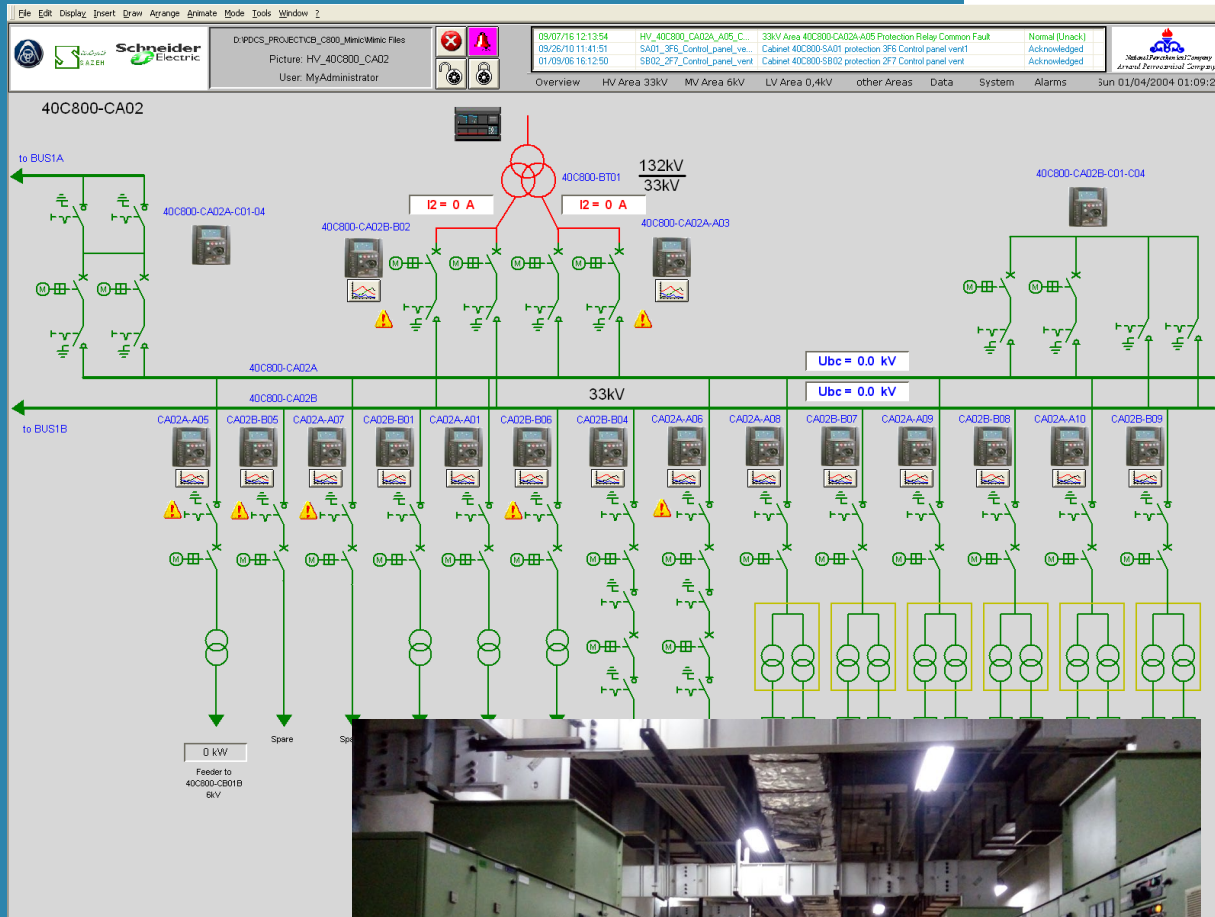



pre-commissioning and commissioning of the water pump station, relay coordination, and test of 33KV feeder, Siemens-1000 liters/s, and other low voltage equipment at Moghan Water Pump Station, Aslandoz, Iran.(2012)





detail engineering and supervision of instrumentation for extending import/export jetty conveyors at Persian Gulf Mining and Metal Industries Special Zone, Bandar Abbas, Iran.(2014)





detail engineering and supervision of Electrical, procurement contractor of Asphalt blowing unit at Behbod Sanat, Birjand, Iran.(2016)

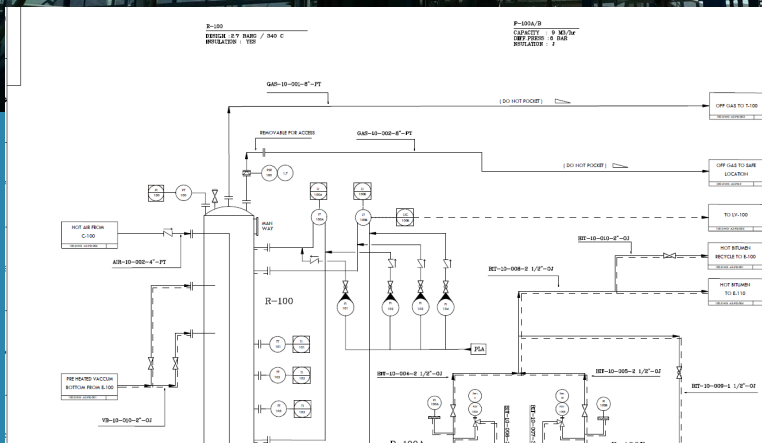
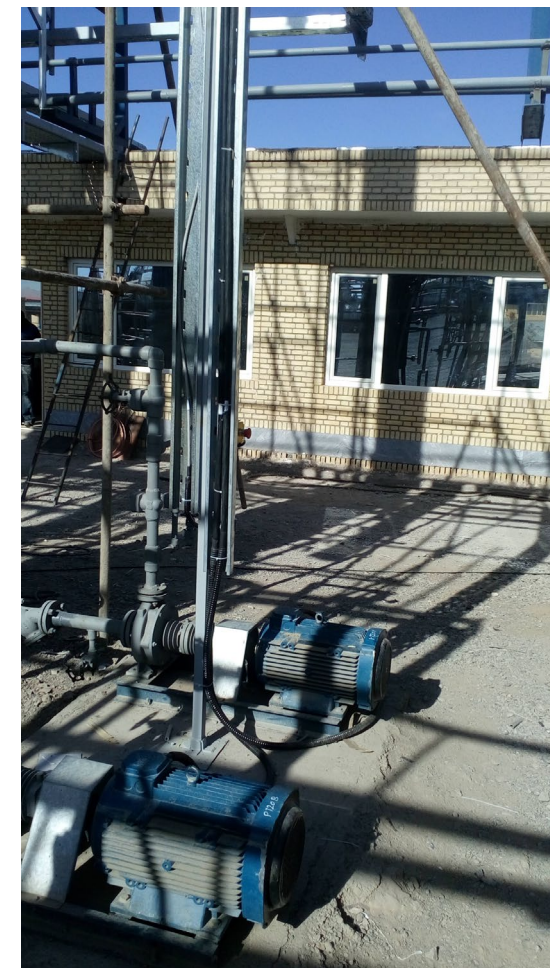
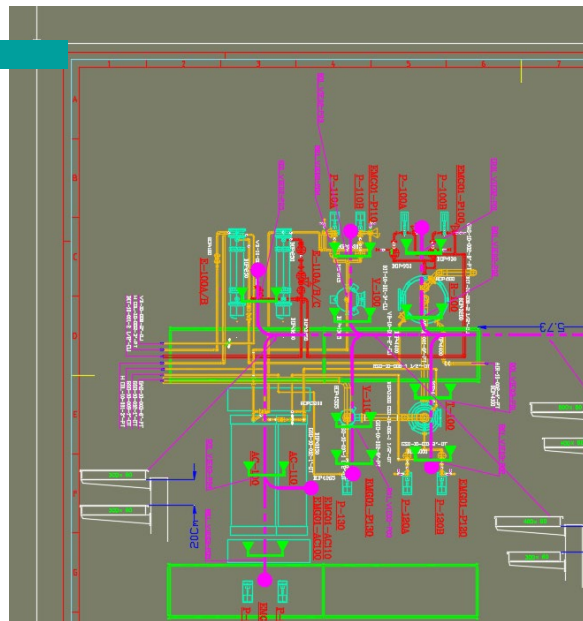



detail engineering, supervision, and commissioning of Electrical, Control, and Instruments for Pozzolana cement production line at Almethali.co in Karbala, Iraq (Holcim and Lafarge plant).(2018)

